



# Amalgatome<sup>®</sup> SD System & Sterilization Tray User Guide

**EXSURCO MEDICAL  
10804 GREEN ROAD  
WAKEMAN, OH 44889**

This page intentionally left blank.

# AMALGATOME® SD USER GUIDE

---

*Instructions for Use*



Exsurco Medical  
10804 Green Road  
Wakeman, OH 44889  
1-800-243-6049  
[www.exsurco.com](http://www.exsurco.com)

## **NOTICE TO USERS**

Read this manual thoroughly before using the Exsurco Medical Amalgatome SD System and Sterilization Tray. It is designed for use by qualified and trained medical professionals where the patient is under supervision of trained personnel. Review this user guide, paying particular attention to all warnings and precautions, prior to any surgical procedure. Improper system set up and operation or failure to follow this user guide can cause injury or damage that is not covered under the warranty.

This page intentionally left blank.

# AMALGATOME<sup>®</sup> SD USER GUIDE

---

## Table of Contents

Table of Contents .....	1
Preface .....	3
Purpose .....	3
Exsurco Medical .....	3
Contact Information.....	3
System Overview.....	5
Indications for Use .....	5
Description .....	6
Components.....	7
How Supplied .....	8
Contraindications.....	9
General Warnings.....	11
Warnings .....	11
General Precautions.....	13
Precautions .....	13
Setup Instructions .....	15
Inspection .....	15
Setup.....	15
System Check and Set Depth Gauge .....	21
Depth Gauge Setting.....	22
Operating Instructions .....	23
Graft Harvesting and Debridement.....	23
Postoperative Procedure .....	26
Disassemble the handpiece from the cutting head.....	27
Cleaning and Sterilization Instructions.....	29
Manual Cleaning of the Sterilization Tray .....	30
Automated Cleaning of the Sterilization Tray.....	31
Manual Cleaning of the Reusable System.....	32
Automated Cleaning of the Reusable System .....	36
Visual Inspection .....	37

# AMALGATOME<sup>®</sup> SD USER GUIDE

---

Sterilization Preparation .....	37
Sterilization .....	39
Troubleshooting.....	41
Warranty, Service, and Returns.....	45
Limited Warranty .....	45
Service .....	46
Returns.....	46
Appendix A: Technical Specifications .....	49
Amalgatome SD System Specifications .....	49
Amalgatome SD Sterilization Tray Specifications.....	49
Appendix B: Parts Information.....	51
Ordering Information.....	53
Appendix C: Glossary of Symbols .....	55
Appendix D: Quick Reference Guides .....	57
Setup.....	57
Postoperative Procedure .....	58
Manual Cleaning of the Reusable System.....	59
Appendix E: References for Sterilization and Details of Validation Report .....	61
References .....	61
Internal Validation Reports .....	61
Help Information .....	63

# AMALGATOME<sup>®</sup> SD USER GUIDE

---

## Preface

### **Purpose**

This user guide provides directions to help users safely and effectively operate the Amalgatome SD System, including the sterilization tray. This guide also includes material such as indications for use, contraindications, and troubleshooting information.

### **Exsurco Medical**

Exsurco Medical's mission is to redefine excision science across the continuum of care through delivery and advancements in clinical solutions, strategic healthcare partnerships, and deep customer understanding. We are committed to improving patients' lives and outcomes by advancing the healing power of skin through innovation, product development, and the marketing of medical devices for healthcare professionals in the surgical and tissue bank markets.

The Amalgatome SD is designed to excise tissue utilizing an innovative excision ring blade technology and is indicated for skin grafting and wound debridement. This new advancement and design incorporate the ability to excise tissue with one device in a precise and efficient manner.

### **Contact Information**

Contact Exsurco Medical at 1-800-243-6049 or via e-mail at [support@exsurco.com](mailto:support@exsurco.com).

# AMALGATOME<sup>®</sup> SD USER GUIDE

---

This page intentionally left blank.



# AMALGATOME<sup>®</sup> SD USER GUIDE

## System Overview

*This section provides general information about the Amalgatome SD System.*

### Indications for Use

The Amalgatome SD System is designed to excise soft tissue in varying widths and thicknesses for skin grafting and wound debridement. It is indicated for open wounds, including wound site preparation (debridement and sharp debridement), removal of necrotic tissue and eschar, and tissue harvesting (autograft harvesting).

The Amalgatome SD Sterilization Tray is only intended for use to contain and protect the Amalgatome SD System (SDSYSTEM024/ SDSYSTEM02/ SDSYSTEM04). This is the only sterilization tray validated to contain the Amalgatome SD system for steam sterilization. This sterilization tray should not be used to sterilize any other instrument.

The maximum product load per sterilization tray includes one each of the following Amalgatome SD System components:

- Hand Piece (Drive Unit)
- Pneumatic Hose
- 4-inch Cutting Head (Blade Head)
- 2-inch Cutting Head (Blade Head)
- 4-inch Lock Ring
- 2-inch Lock Ring
- Lock Ring Removal Tool
- Lock Nut Wrench



*Figure 1: Fully Assembled Amalgatome SD Sterilization Tray*

# AMALGATOME<sup>®</sup> SD USER GUIDE

---

## **Description**

The Amalgatome SD System is a pneumatically powered surgical skin grafting instrument capable of producing varying thicknesses of skin grafts from 0.005 to 0.045 inches in increments of 0.001". Single-use disposable, excision ring blades provide precision cutting and are available in 2-inch and 4-inch diameters, depending on the size of the graft needed or debridement site.

The Amalgatome SD is also capable of soft tissue excision (removal of necrotic tissue and eschar) and wound site preparation of the surgical site in applications (acute, chronic wounds, and burns) that in the physician's clinical judgment require debridement and sharp debridement.

The Amalgatome SD Sterilization Tray consists of an anodized aluminum base, nylon coated instrument brackets, internal instrument tray with component placement identifiers, handles, and a lid. The inserts to hold the individual components are configured within the sterilization tray specifically for securing the Amalgatome SD System components.

# AMALGATOME<sup>®</sup> SD USER GUIDE

## Components



Figure 1. Device Components

1. Pneumatic hose
2. 4-inch Lock Ring
3. 4-inch Cutting Head (excision ring blade head)
4. 2-inch Cutting Head (excision ring blade head)
5. 2-inch Lock Ring
6. Handpiece (Drive Unit)
7. Lock Nut Wrench
8. Lock Ring Removal Tool

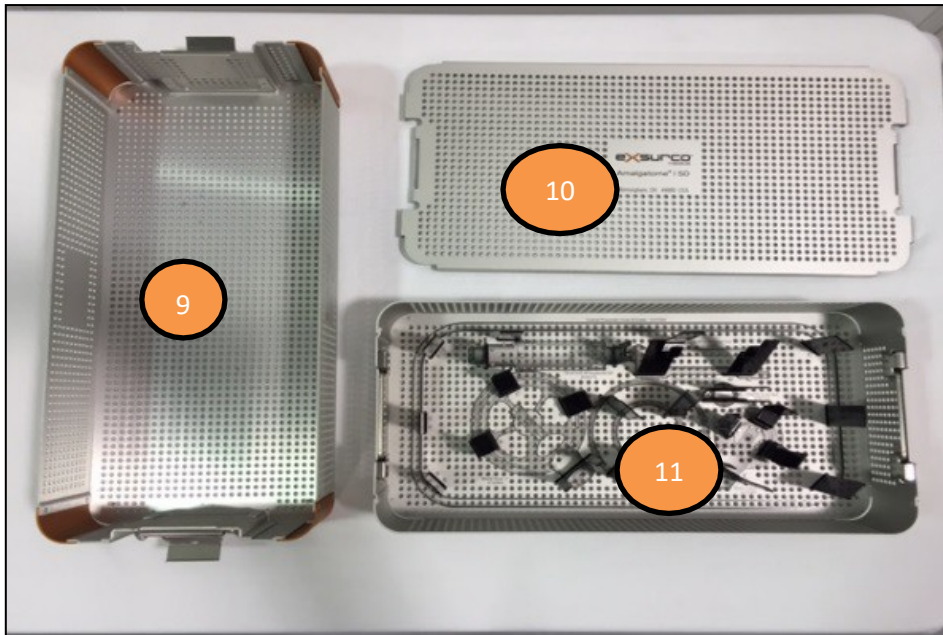

Figure 2. Tray Components

9. Base
10. Lid
11. Internal Instrument Tray

For additional part number information, refer to Appendix B: Parts Information.

# AMALGATOME<sup>®</sup> SD USER GUIDE

---

## How Supplied

- The Amalgatome SD System consists of the following components as shown on previous page:
  - Handpiece (Drive Unit): Consists of the motor and pneumatic hose which powers the system.
  - Interchangeable cutting heads with lock ring and assembly accessories.
  - The single-use disposable surgical excision ring blades are supplied separately.
- The complete system is shown and is sold with the custom-made sterilization tray, which should be utilized with this system only.
  - SDSYSTEM024 contains the 2-inch and 4-inch cutting heads.
  - SDSYSTEM04 contains the 4-inch cutting head.
  - SDSYSTEM02 contains the 2-inch cutting head.
- The system is provided non-sterile and is reusable after cleaning and sterilization prior to use according to the procedures outlined in this document.
- Each piece of the system is shipped individually contained in protective suspension or retention boxes and each must be opened, visually inspected, cleaned and then placed in the sterilization tray for sterilization.
- The single-use, disposable excision ring blades are provided sterile and sold separately. The single use excision ring should be considered sterile unless the sterile packaging has been opened or damaged.

**WARNING:** Re-sterilization or reuse of the disposable excision ring blades can result in serious physical harm to the patient. Excision ring blades are for single use and must not be reused.

- The Amalgatome SD Sterilization Tray is supplied non-sterile and is usable after cleaning and sterilization prior to use according to the procedures in the Operating Instructions section.
- It is packaged one per box.
- The sterilization tray must be inspected prior to cleaning and sterilization for any damages upon receipt.

# AMALGATOME<sup>®</sup> SD USER GUIDE

---

## **Contraindications**

The Amalgatome SD System is not recommended for use on the following locations on the body or where surgeon determines due to health reasons for skin grafting:

- Eyelid(s)
- Post auricular region (behind the ear) and on the ear
- Inguinal region (groin)
- Genital region
- Forearm (underside of wrists up to the elbow)
- Supraclavicular area (above the collarbone)

NOTE: If device is used in these areas for debridement and/or excision it is at the surgeons discretion.

# AMALGATOME<sup>®</sup> SD USER GUIDE

---

This page intentionally left blank.

# AMALGATOME<sup>®</sup> SD USER GUIDE

---

## General Warnings

*This section provides general warnings about the Amalgatome SD System.*

### Warnings

- The user of the Amalgatome SD System must be a surgically trained professional (e.g., a surgeon) and thoroughly familiar with the function, application, and instructions for use in order to avoid injury to the patient and operating staff.
- Each physician must evaluate the appropriateness of the technique for each patient based on his or her own medical training and expertise. Care should be taken in treating individuals with pre-existing conditions that might affect the success of the surgical procedure. Every patient is different, and results can vary.
- This device can cut soft tissue. Apply only to tissues and debris intended to be excised from the wound.
- Only use the Amalgatome SD sterile, disposable, excision ring excision ring blades with the Amalgatome SD System.
- Do not use blades from other manufacturers.
- Do not reuse the excision ring blades as they are intended for single use. Serious injury can result from use of other manufacturer's excision ring blades or reuse of the Amalgatome SD excision ring blades. Dispose of the excision ring blades in accordance with facility protocol for sharps containment.
- Sharpening of the excision ring blade or removal of excision ring blade material will result in loss of calibration.  
Care should be taken when removing the excision ring from its packaging. The excision rings are extremely sharp.

# AMALGATOME<sup>®</sup> SD USER GUIDE

---

This page intentionally left blank.



# AMALGATOME<sup>®</sup> SD USER GUIDE

---

## General Precautions

*This section provides general precautions about the Amalgatome SD System and Sterilization Tray.*

### **Precautions**

- The Amalgatome SD System operator and other clinical personnel should follow the universal protocol for aseptic technique as with all surgical procedures.
- As with all surgical procedures, the surgical team and clinical personnel should follow the universal precautions for infection control. (including the use of surgical gloves, facemask that covers the mouth and nose, protective eye wear or shield, protective clothing and anti-slip shoe covers.) Especially during debridement procedures due to possible tissue spray
- It is recommended prior to clinical use of the Amalgatome SD System, that all operators of the system be trained in its proper use. Contact your local Exsurco Medical Sales Representative for all details regarding Amalgatome SD training.
- United States of America (USA) federal law restricts this device to sale by or on the order of a physician.
- The Amalgatome SD Sterilization Tray is only compatible with the Amalgatome SD System and has not been validated for any other instruments.
- Do not use any other sterilization tray for the Amalgatome SD System (including casket system); if any other sterilization tray is used, the facility is responsible for the internal sterilization validation.
- Do not use the sterilization tray if it is damaged or shows signs of cracking, flaking, peeling, or deformity in any manner.
- Do not use if any of the internal brackets are bent, damaged, or broken; sterility and integrity of the system could be compromised.
- Always follow the Amalgatome SD System User Guide (Part #: X101456) for safe handling of the system.
- Do not use if the lid does not securely attach to the base; damage to the Amalgatome SD System components inside the sterilization tray could occur.

# AMALGATOME<sup>®</sup> SD USER GUIDE

---

This page intentionally left blank.

# AMALGATOME<sup>®</sup> SD USER GUIDE

## Setup Instructions

*This section describes how to inspect, safely setup, use, and maintain the Amalgatome SD System and Sterilization Tray.*

### Inspection (Upon Receipt)

1. Verify that the Amalgatome SD Sterilization Tray is free of damage and particulate. If any contaminants are present, re-clean the sterilization tray. For more information, refer to the Cleaning procedure.
2. Verify that all latches and inserts are secure and in working order.
3. Inspect all movable parts of the Amalgatome SD system, in order to ensure that the parts function through the intended range of motion.  
Do not use or reprocess damaged or defective parts. If the system does not function correctly, contact Exsurco Medical Customer Service at 1-800-243-6049, ext. 4, or email support@exsurco.com for repair or replacement.
4. Inspect the O-ring on the handpiece of the device. Wear on the O-ring is expected. During the annual preventative maintenance program, the O-ring will be replaced. Do not use if the O-ring is cut or severed in half or missing. Do not attempt to replace the O-ring.

### Setup

Perform the following procedures before each use. Follow sterile field aseptic technique per the Association of periOperative Registered Nurses (AORN) guidelines and hospital protocol. Open, inspect, and set up the sterile Amalgatome SD system, contained within the sterilization tray, and disposable excision ring blades within the sterile field.

Refer to Appendix D: Quick Reference Guide for a pictorial reference to this procedure.

1. Assemble the cutting head onto the handpiece.



*Figure 1a*



*Figure 1b*

- a. Hold the handpiece in the upright position, with the protruding gear facing upward and the **ON/OFF** lever facing the user.
- b. Align key slot on the handle onto the pin on the head of the system.

# AMALGATOME<sup>®</sup> SD USER GUIDE



Figure 1c

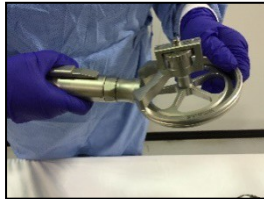

Figure 1d

c. Hand-tighten the locking knob clockwise until it stops; do not over tighten.

d. Adjust the depth gauge to the preferred operating setting.

2. Open and install the disposable excision ring blade.



Figure 2a

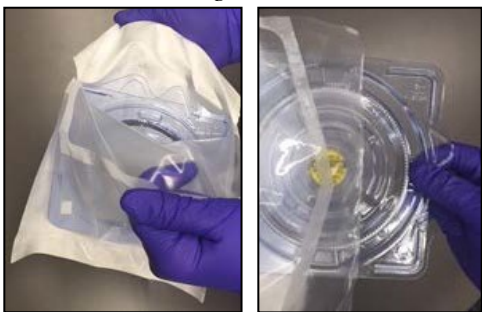

Figure 2b

a. Check the package integrity and the expiration date. Inspect the disposable excision ring blade for possible damage, wear, or defects. Ensure that the excision ring blade is free of particulate and burrs. Discard the excision ring blade if it is damaged or defective.

b. Using the peel-pack end with peel corners, pull open the package, allowing the sterile operator to reach in and grab the clamshell.

# AMALGATOME<sup>®</sup> SD USER GUIDE

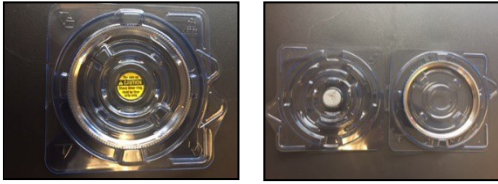

Figure 2c

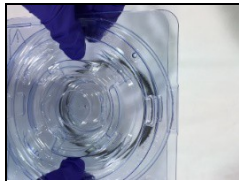

Figure 2d

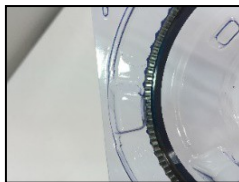

Figure 2e

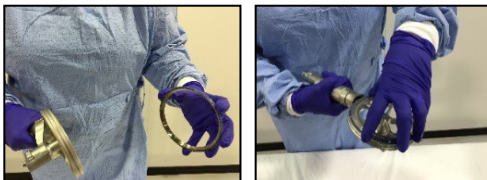

Figure 2f

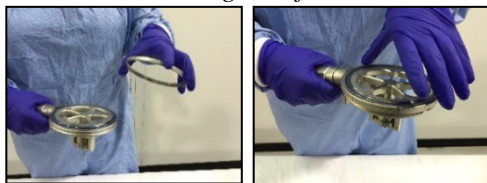

Figure 2g



Figure 2h

c. Open the clamshell containing the excision ring blade – (similar to opening a book – right to left), yellow caution sticker should be facing up. When clamshell is opened it will be teeth side up

d. Fold the left (empty) side of the clamshell under the excision ring blade side, and then turn the clamshell over.

e. While standing close to the table or sterile surface, use the thumb notches on the tray to release the excision ring blade out of the clamshell onto the sterile surface.

**CAUTION:** At this time the excision ring blade is lying teeth side down on the sterile surface. Do not touch the inner ring of the excision ring blade. It is the sharp cutting surface.

f. Hold the outer edge of the excision ring blade by grasping the blue strip and load the excision ring blade into the handpiece. While nesting the excision ring blade, turn its outer edge slightly in order to ensure proper seating.

g. Place the excision ring blade lock ring over the excision ring blade and twist it in a clockwise motion until it stops. Do not over tighten.

h. There is an additional option for opening the clamshell and dropping the excision ring blade directly into the cutting head. See photos explaining this technique. Open clamshell, fold over and when dispensing excision ring with thumb tabs depress directly into cutting head.

# AMALGATOME<sup>®</sup> SD USER GUIDE

## 3. Attach the pneumatic hose.

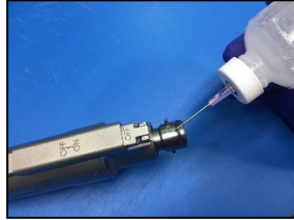

Figure 3a

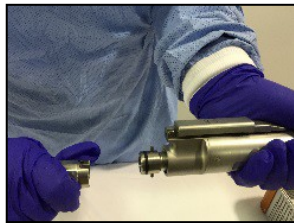

Figure 3b



Figure 3c



Figure 3d

- a. Lubricate the O-ring prior to connecting the air hose with sterile mineral oil. This will help make the female end of the air hose easier to attach to the male end of the handpiece using the toggle barbs. Do not bend hose at a 90° angle at the connection site. Do not use excessive force during the process.
- b. Connect the female end of the pneumatic hose to the male end of the handpiece, securing with the twist-lock feature.

- c. Grasp the hose and attach the hose to the swivel connector on the handpiece. Turn the hose clockwise to secure.

**NOTE:** If the connection seems difficult to attach it is acceptable to place a few drops of sterile mineral oil on the O-ring to help engage the connection.

**NOTE:** Use caution not to drop the hose prior to assembly.

- d. Pass the other end of the pneumatic hose to the circulator. Using a non-perforated holder, clip or secure the pneumatic hose to the sterile field, taking care not to compress the hose.

# AMALGATOME<sup>®</sup> SD USER GUIDE

---



*Figure 3e*

- e. Connect the male end of the pneumatic hose to the appropriate air source in the operating room designated for the procedure.

**NOTE:** The male end of the hose connects to a Schrader<sup>®</sup> style quick connect female coupler indexed for air.

- f. Turn on the air or gas supply, and then verify the pressure while the system is running.

**CAUTION:** Use hospital grade compressed air or nitrogen at the recommended setting of 100 psi.

# AMALGATOME<sup>®</sup> SD USER GUIDE

---

This page intentionally left blank.



# AMALGATOME<sup>®</sup> SD USER GUIDE

## System Check and Set Depth Gauge

*This section describes the process for checking the system and setting the depth gauge.*

**NOTE:** This process must be performed over a sterile surface.

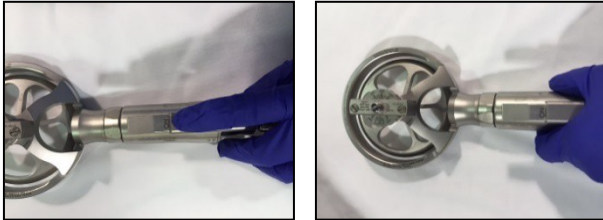

*Figure 1a*



*Figure 2a*



*Figure 3a*

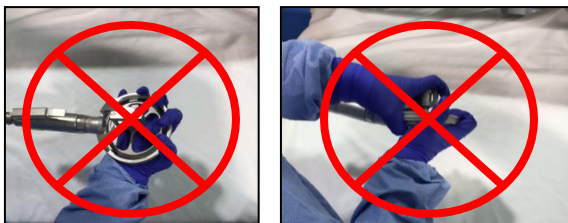

*Figure 4a: Passing the Handpiece*

1. Slide the **ON/OFF** lever on the handpiece to the **ON** position.

2. Press down on the **ON/OFF** lever to activate the system. It is now **ON**.

*When the system activates, the disposable excision ring blade spins.*

3. Verify that all connections are secure and that the air pressure is set correctly while the system is running.

**NOTE:** The required air pressure setting is 100 psi.

4. Release the **ON/OFF** lever, and then slide it to the **OFF** position.

*The system deactivates, and the disposable excision ring blade stops spinning. The system is now ready to be used for the procedure.*

**CAUTION:** Always pass the handpiece from one person to another with the **ON/OFF** lever in the **OFF** position. Do not grab or pass the handpiece by the cutting head due to the risk of contact with the excision ring blade.

# AMALGATOME<sup>®</sup> SD USER GUIDE

## Depth Gauge Setting

The settings on the depth adjustment knob indicate increments of 0.001 inches (0.0254 mm) and cover a range of 0.005 to 0.045 inches (0.127 to 1.143 mm).

The depth gauge settings are a guide only and the resulting skin graft is dependent upon the individual patient demographics (e.g. age, weight, ethnicity, etc.).

Rotate the depth adjustment knob to the left (counterclockwise) for thinner settings and to the right (clockwise) for thicker settings. The depth gauge setting can be changed at any time during the procedure.

When device is not in use during a surgical procedure, it is recommended to set the depth to the lowest (thinnest) setting of 0.005". This will reduce the risk of the excision ring cutting the surface being exposed.

**WARNING:** When device is assembled do not lay the cutting head directly on top of the pneumatic air hose. This step prevents a potential for nicks or cuts that can occur in the hose if it comes in contact with the blade.

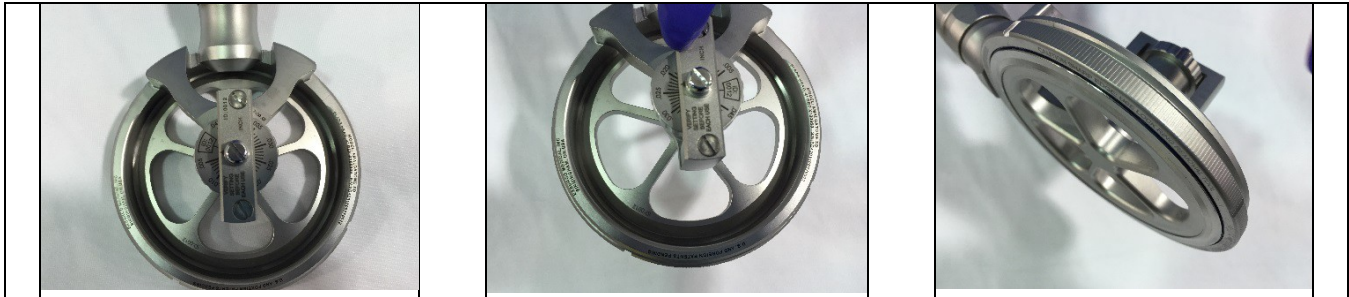

*Figure: Setting the Depth Gauge*

**CAUTION:** Do not disassemble the depth gauge. The gauge can lose calibration and must be returned to Exsurco Medical for recalibration if tampered with. Never remove the screws or components on the gauge knob for cleaning or sterilization. They must always stay intact. Do not remove screws

# AMALGATOME<sup>®</sup> SD USER GUIDE

---

## Operating Instructions

*This section describes the process for graft harvesting and debridement, and post-operative procedures.*

### Graft Harvesting and Debridement

- The Amalgatome SD System is designed for use by qualified and trained medical professionals where the patient is under supervision of trained personnel.
- Each physician must evaluate the appropriateness of the technique used for each patient which should be based on his or her own medical training and expertise.
- Care should be taken in treating individuals with pre-existing conditions that can affect the success of the surgical procedure.
- Every patient is different, and results can vary.
- It is recommended to always begin debridement and skin grafting procedures on a low depth setting and increase the depth gauge as necessary to the optimal setting. The surgical site should be selected per facility protocol for the surgical procedure as determined for skin grafting or wound debridement.
- Skin should be prepared per hospital protocol.

1. Lubricate the skin graft site with sterile mineral oil or sterile water in order to decrease excision ring blade resistance through the tissue.

**NOTE:** Prolonged exposure to saline can damage the handpiece or cause pitting or corrosion.

2. Set the depth gauge to the desired setting.
3. Activate the system by sliding the **ON/OFF** lever to the **ON** position and pressing down on the lever.

*When the system activates, the disposable excision ring blade spins.*

4. Position the cutting head at the desired starting point, and then apply a slight downward pressure to ensure the cutting edge of the disposable excision ring blade maintains contact with the recovery site. Only light pressure is required.

**NOTE:** The system cuts with the trailing edge of the excision ring blade. See Figure 5a for explanation of trailing edge. The trailing edge means this is where the cut starts.

*The excision begins.*

# AMALGATOME<sup>®</sup> SD USER GUIDE

5. Move the cutting head in the desired direction, maintaining a slow and steady speed in order to ensure that the desired graft thickness and width is recovered.

**NOTE:** At any point during the procedure the depth gauge setting can be adjusted by turning the depth adjustment knob on the gauge either to the left (counterclockwise) to decrease the thickness or to the right (clockwise) to increase the thickness.

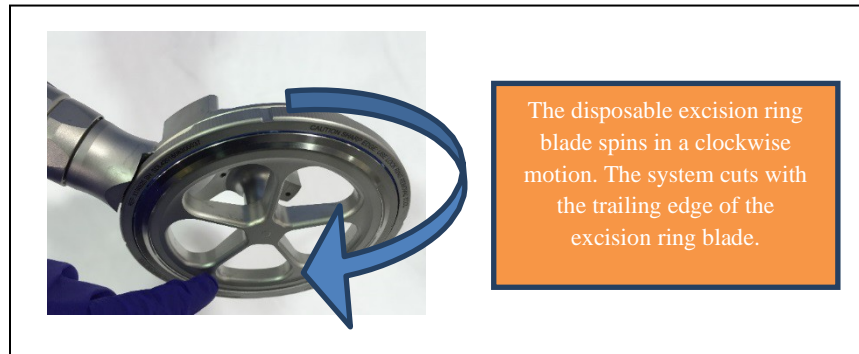

Figure 5a

*The excision continues, and the skin graft and/or debrided tissue starts to emerge from the cutting head.*

6. Use either of the following methods to collect the recovered graft or debrided tissue:
  - Method 1: Use tissue forceps to gently lift the graft as it emerges from the cutting head. Do not stretch or pull the graft as it emerges from the cutting head.
  - Method 2: When the graft emerges from the cutting head, allow the graft to collect in the cutting head.

**NOTE:** There is a 15° angle built into the handle, so you do not need to hold the handpiece at an angle to recover a skin graft or debrided tissue. For additional pictorial reference, refer to the figures on the following page.

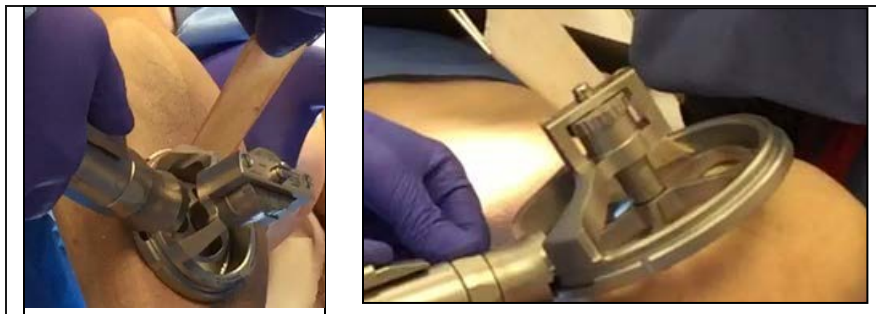

Figure 6a

# AMALGATOME<sup>®</sup> SD USER GUIDE

## Cross Section Diagrams

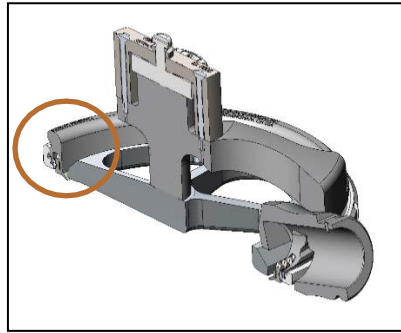

Figure 6b: Magnified view of cutting head

Direction of motion

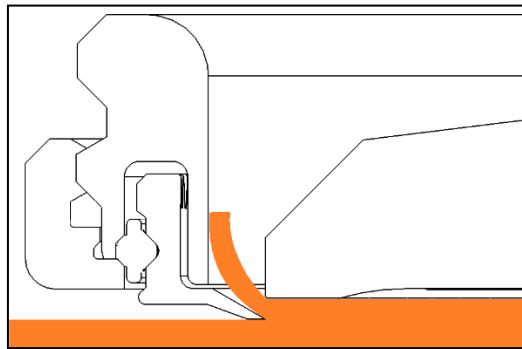

Figure 6c: Cutting portion or "trailing edge" of the instrument held parallel to the patient. Demonstrating good excision ring blade engagement.

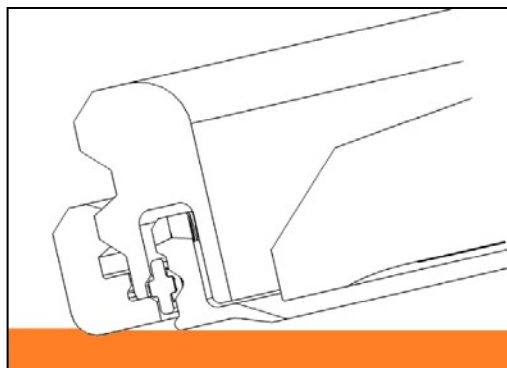

Figure 6d: Cutting portion or "trailing edge" of the instrument held at an angle to the patient. Excision ring blade edge is not in contact.

# AMALGATOME<sup>®</sup> SD USER GUIDE

---

*As you collect the recovered graft, the excision continues.*

7. To end the graft recovery, sever the graft, or stop procedure, move the handpiece in an angled, upward motion away from patient's body. This causes the excision ring blade to cut off the end of the graft.

*The disposable excision ring blade cuts off the end of the skin graft.*

8. Release the **ON/OFF** lever, and then slide it to the **OFF** position.

*The system deactivates, and the disposable excision ring blade stops spinning.*

9. For wound debridement, once the surgical site is prepped and determined, begin to debride using techniques per hospital protocol until the wound bed is properly debrided and ready for the next step in the wound care protocol.
10. If the device seems to appear "sluggish" or the motor RPM seems to struggle or not perform as normal, it is acceptable to place a few drops of sterile mineral oil down into the pinion of the handpiece to lubricate the motor.
11. If the cutting head and excision ring have debris and tissue it is acceptable to "clean" the device during the procedure. Place cutting head at an angle into a sterile bowl of sterile water, activate the device, and allow it to run submerged in the water. As the excision ring spins it will clear out the excess debris collected.
12. During the procedure, when the device is not being used and in the OFF position, it is recommended to place on back table or sterile field location NOT on top of patient or in the operating zone, but in an easy to accessible sterile location when needed.

## **Postoperative Procedure**

Perform this procedure after the skin graft has been recovered or the wound debridement procedure is completed and the Amalgatome SD has been returned to the surgical back table or instrument table. Refer to Appendix D: Quick Reference Guides for a pictorial reference guide to this procedure.

1. Disconnect the pneumatic hose from the wall source.
2. Use a "push in and twist" motion to unlock it from the security tab and disconnect the pneumatic hose from the handpiece.
3. Place the pneumatic hose in the instrument tray.
4. Remove the disposable excision ring blade from the handpiece. **NOTE:** Surgical team **MUST** remove the excision blade from device and dispose of prior to sending device to SPD for reprocessing.
  - a. Use the lock ring removal tool to loosen the excision ring blade lock ring by engaging the tool with the notches in the lock ring and using a counterclockwise motion to remove the ring.
  - b. Turn the handpiece lever-side-up and allow the excision ring blade to release freely onto the table.

**CAUTION:** At this time, the excision ring blade is lying gear teeth side down on the table. Do not touch the inner ring of the excision ring blade. It is the sharp cutting surface. Only handle the blue strip on the outside.

- c. Taking care as to not touch the inner ring, grasp the outer ring excision ring blade around the blue strip and dispose of properly in a designated sharps container per hospital protocol.
- d. Place the lock ring and lock ring removal tool back into the sterilization tray.

# AMALGATOME<sup>®</sup> SD USER GUIDE

---

## **Disassemble the handpiece from the cutting head**

1. If the handpiece contains debris or is slippery, first loosen the locking knob, or collar, on the handpiece using the locking tool. Once it begins to loosen, using a counterclockwise motion, loosen the cutting head from the handpiece with hands.
2. Using sterile water, remove any apparent debris from the Amalgatome SD components in order to prevent the drying of blood and body fluids.
3. Place the cutting head into the sterilization container.
4. Place the handpiece into the sterilization tray.

Once all components are disassembled, follow facility protocol to return the used Amalgatome SD System and sterilization tray to central sterile (SPD) department for cleaning and reprocessing.

### **CAUTION:**

- Do not allow blood, tissue, or disinfectants to dry on any part of the Amalgatome SD System.
- Do not use cleaning agents with chlorine or chloride (e.g., saline or bleach) as the active ingredient as they are corrosive to stainless steel and can result in physical damage to the system, including rust and corrosion.
- Do not use saline as it has a corrosive effect on stainless steel and can result in physical damage to the system.
- Always use cleaning agents that are safe for surgical instruments and stainless steel.
- Immediately disconnect the pneumatic hose once the surgical case is complete.
- Do not lay device on patient when not in use, place on back table or accessible sterile field location.

# AMALGATOME<sup>®</sup> SD USER GUIDE

---

This page intentionally left blank.



# AMALGATOME<sup>®</sup> SD USER GUIDE

---

## Cleaning and Sterilization Instructions

*This section describes the Amalgatome SD System and sterilization tray cleaning and sterilization requirements.*

The Amalgatome SD system and sterilization tray are reusable and requires cleaning and sterilization prior to reuse. Manual cleaning and Automated Cleaning have both been validated for use with the system. It is important to exercise care when handling the components to protect them from physical damage. Only remove the components as instructed in the following procedures. Any further disassembly of the system can cause damage and/or loss of calibration and will void the warranty. The system contains no user-serviceable parts and must be returned to Exsurco Medical for repair and maintenance.

As with any decontamination procedure, follow the accepted guidelines for hand washing, use of personal protective equipment (PPE), etc., as recommended by the Association for the Advancement of Medical Instrumentation (AAMI) Standards and Recommended practice, *Safe Handling and Biological Decontamination of Medical Devices in Health Care Facilities and in Non-Clinical Settings, current version of ANSI/AAMI ST35.*

### CAUTIONS:

- Do not allow blood, tissue, or disinfectants to dry on any part of the Amalgatome SD System.
- Do not use cleaning agents with chlorine or chloride (e.g., saline or bleach) as the active ingredient as they are corrosive to stainless steel and can result in physical damage to the system, including rust and corrosion.
- Do not use saline as it has a corrosive effect on stainless steel and can result in physical damage to the system.
- Always use cleaning agents that are safe for surgical instruments and stainless steel.
- Never place the pneumatic hose in any kind of automated washing system.
- Always inspect instruments and devices for rust and corrosion per AORN and hospital protocols.

# AMALGATOME<sup>®</sup> SD USER GUIDE

---

## Manual Cleaning of the Sterilization Tray

1. Prepare a neutral pH or instrument-safe enzymatic cleaning solution according to the cleaning solution manufacturer specifications.



*Figure 1a*

2. Disassemble the tray into its individual components:
  - Base
  - Lid
  - Internal instrument tray

**NOTE:** For additional part number information, refer to Appendix B: Parts Information.

3. Rinse each component under running tap water for a minimum of one minute in order to remove excess soil.
4. Immerse the base, internal instrument tray, and lid into the cleaning solution and let soak for a minimum of five minutes. Do not immerse the unit overnight.
5. While still immersed in the cleaning solution, use a non-metal, soft-bristled brush moistened with cleaning solution to scrub each component for a minimum of two minutes each and until visibly clean.
6. Place each component in a tap water bath for a minimum of one minute, and then repeat one time using fresh tap water. Do not immerse the unit overnight.
7. Place each component in a critical water (e.g., deionized (DI), reverse osmosis (RO), or distilled water) bath for a minimum of one minute. Do not immerse the unit overnight.
8. Using a sterile, lint-free wipe, dry each component. Use multiple wipes as necessary.
9. In a well-lit area, visually inspect each component in order to ensure all surfaces are clean and dry.

# AMALGATOME<sup>®</sup> SD USER GUIDE

## Automated Cleaning of the Sterilization Tray

1. Prepare a neutral pH or instrument-safe enzymatic cleaning solution according to the cleaning solution manufacturer specifications.
2. Disassemble the tray into its individual components:
  - a. Base
  - b. Lid
  - c. Internal instrument tray

**NOTE:** For additional part number information, refer to Appendix B: Parts Information.

3. Rinse each component under running tap water for a minimum of one minute in order to remove excess soil.
4. Immerse the base, internal instrument tray, and lid into the cleaning solution and let soak for a minimum of two minutes. Do not immerse the unit overnight.
5. While still immersed in the cleaning solution, use a non-metal, soft-bristled brush moistened with cleaning solution to scrub each component for a minimum of one minute each and until visibly clean.
6. Place each component in a tap water bath for a minimum of one minute, and then repeat one time using fresh tap water. Do not immerse the unit overnight.
7. Follow the below automated wash instructions:

**Table 1 (Automated Cleaning Instructions for Use- Sterilization Tray)**

Cycle	Time (minutes: seconds)	Minimum Temperature	Type of Detergent/ Water
Prewash	2:00	Cold	Tap
Wash	4:00	Heated Tap (60°C)	Enzymatic Cleaner (per the manufacturer's instructions)
Neutralize	2:00	Hot Tap	Neutral Detergent (per the manufacturer's instructions)
Rinse	0:15	Hot or Heated	Tap
Thermal Rinse	5:00	Heated (90°C)	Heated Deionized or High Purity Water
Dry	15:00	High (98.8°C)	NA

8. Using a sterile, lint-free wipe, dry each component. Use multiple wipes as necessary.
9. In a well-lit area, visually inspect each component in order to ensure all surfaces are clean and dry.

# AMALGATOME<sup>®</sup> SD USER GUIDE

## Manual Cleaning of the Amalgatome SD Reusable System

1. Prepare a neutral pH or instrument-safe enzymatic cleaning solution according to the cleaning solution manufacturer specifications.
2. Using the lock nut wrench that is provided with the system, remove the locking knob and locking nut.

**NOTE:** This is a left-handed thread. Turning the knob and nut clockwise loosens or removes them.

**NOTE:** These are two separate components so keep them together with other components and take care not to misplace them.

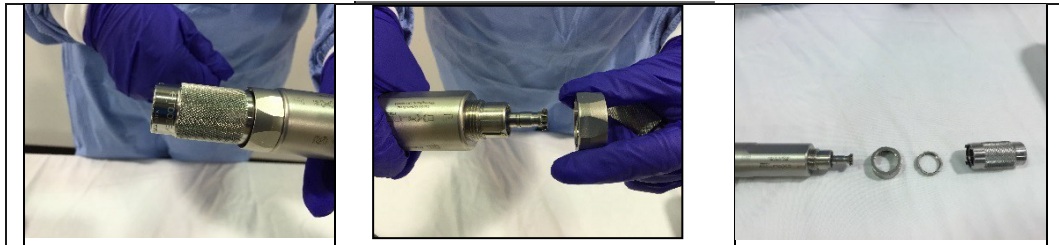

Figure 2a

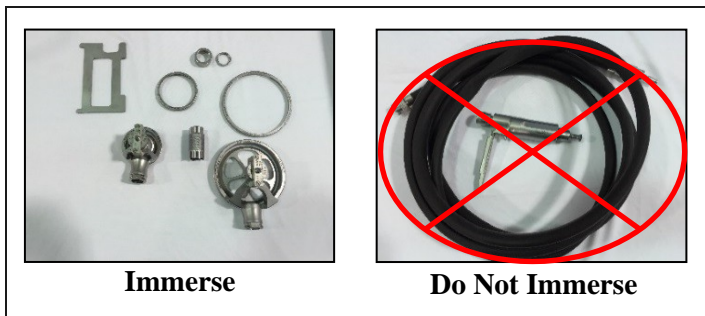

Figure 3a



Figure 4a

3. With the exception of the handpiece and pneumatic hose, immerse the components into the cleaning solution and let soak for a minimum of two minutes. Do not immerse the unit overnight.

**NOTE:** For additional part number information, refer to Appendix B: Parts Information.

4. Using a lint-free wipe moistened with the cleaning solution, wipe the handpiece and the pneumatic hose for a minimum of one minute each.

**CAUTION:** Do not immerse the handpiece or pneumatic hose into the cleaning solution.

# AMALGATOME<sup>®</sup> SD USER GUIDE

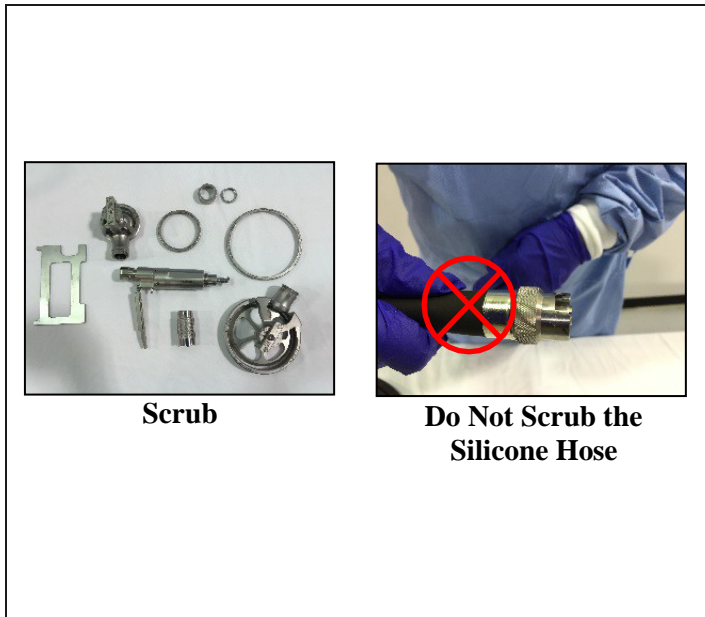

Figure 5a

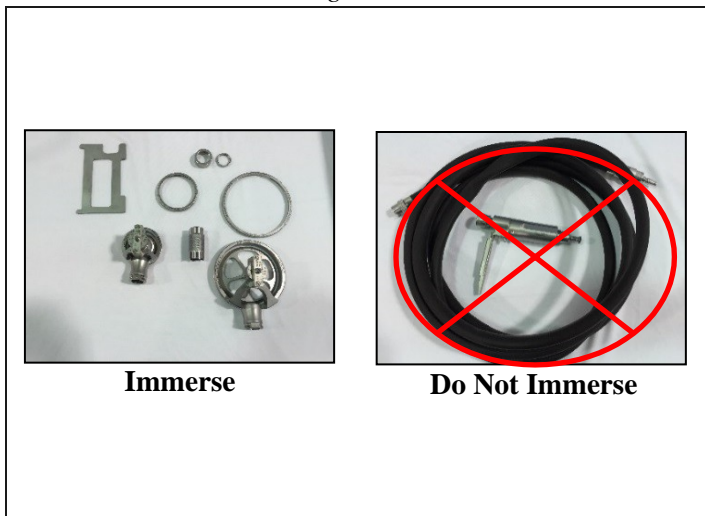

Figure 6a



Figure 7a

- Using a non-metal, soft-bristled brush moistened with the cleaning solution, scrub all of the components with the exception of the silicone portion of the tubing for a minimum of 30 seconds each and until visibly clean.

**NOTE:** For additional part number information, refer to Appendix B: Parts Information.

**CAUTION:** Do not scrub the silicone portion of the pneumatic hose. Never place hose in automated washing system.

**CAUTION:** Do not immerse the handpiece or pneumatic hose into the cleaning solution.

- With the exception of the handpiece and pneumatic hose, place the components into a fresh tap water bath for a minimum of one minute, and then repeat one time using fresh tap water. Do not immerse the unit in water. In the event the unit is immersed in water please hold with end where pneumatic hose attaches to allow for water to drain out.

**NOTE:** For additional part number information, refer to Appendix B: Parts Information.

**CAUTION:** Do not immerse the handpiece or pneumatic hose into the water.

- Moisten a sterile, lint-free wipe with tap water, and wipe the handpiece and pneumatic hose for a minimum of one minute each. Use multiple wipes as necessary. Repeat this step one time using fresh wipes.

**CAUTION:** Do not immerse the handpiece or pneumatic hose into the water.

# AMALGATOME<sup>®</sup> SD USER GUIDE



Figure 8a



Figure 9a



Figure 10a

8. With the exception of the handpiece and pneumatic hose, place the components into a critical water (e.g., DI, RO, or distilled water) bath for a minimum of one minute. Do not immerse the unit overnight.

**NOTE:** For additional part number information, refer to Appendix B: Parts Information.

**CAUTION:** Do not place the handpiece or pneumatic hose into the critical water (e.g., DI, RO, or distilled water) bath.

9. Moisten a sterile, lint-free wipe with critical water, and wipe the handpiece and pneumatic hose for a minimum of one minute each. Use multiple wipes as necessary.

**CAUTION:** Do not immerse the handpiece or pneumatic hose into the critical (e.g., DI, RO, or distilled water) water.

10. Using a sterile, lint-free wipe, dry each component. Use multiple wipes as necessary.

11. In a well-lit area, visually inspect each component in order to ensure all surfaces are clean and dry.

# AMALGATOME<sup>®</sup> SD USER GUIDE

12. Using the lock nut wrench, replace the locking knob and locking nut back onto the handpiece.

**NOTE:** This is a left-handed thread. Turning the knob and nut counterclockwise tightens or replaces them.

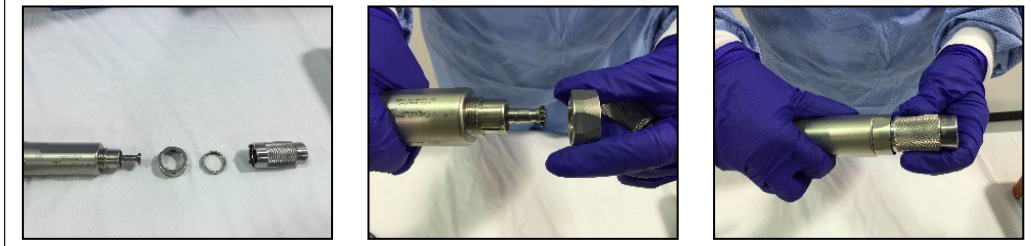

*Figure 12a*

**NOTE:** It is important when re-assembling the lock nut and locking knob back onto the handpiece the lock nut and locking knob are placed in the proper order and orientation on the handpiece.

a. Below is a closeup showing the connection of the lock nut onto the wrench, and the locking knob onto the handpiece for ease in assembly. To assemble lock nut onto wrench, place lock knob over top of lock nut on wrench ensuring the “U” facing UP.



*Figure 12b*

13. Slide wrench (with lock nut and lock knob on) over the pinion of handpiece to engage at base of handpiece and screw on, finger tight, counter clockwise till secure. The design on the handpiece should match the lock knob, and when looking down onto the handpiece the bottom of the U should be facing out.



*Figure 13a*

# AMALGATOME<sup>®</sup> SD USER GUIDE

## Automated Cleaning of the Amalgatome SD Reusable System

Please follow steps outlined above in the manual cleaning section 1-7. For automated cleaning it is the same pre-cleaning protocol for the components. When finished with step 7 above, stop (Do Not Follow Steps 8-10). Place the disassembled components into a wire basket (see pictures below).



Figure 1a

**NOTE:** Leave components disassembled to the extent shown in the pictures. The locking knob and lock nut should remain **DISASSEMBLED** from the handpiece. Lock rings should not be threaded onto the head assembly.

Follow the automated cycle parameters validated below:

**NOTE:** Load the Handpiece, open end facing down, an angle (to allow for draining) into the washer-disinfector.

**Table 1 (Automated Cleaning Instructions for Use- Reusable System)**

Cycle	Time (minutes: seconds)	Minimum Temperature	Type of Detergent/ Water
<b>Prewash</b>	2:00	Cold	Tap
<b>Wash</b>	4:00	Heated Tap (60°C)	Enzymatic Cleaner (per the manufacturer's instructions)
<b>Neutralize</b>	2:00	Hot Tap	Neutral Detergent (per the manufacturer's instructions)
<b>Rinse</b>	0:15	Hot or Heated	Tap
<b>Thermal Rinse</b>	5:00	Heated (90°C)	Heated Deionized or High Purity Water
<b>Dry</b>	15:00	High (98.8°C)	NA

Upon completion of the automated cycle, inspect as outlined below:

10. In a well-lit area, visually inspect each component in order to ensure all surfaces are clean and dry.

11. Using the lock nut wrench, replace the locking knob and locking nut back onto the handpiece.



# AMALGATOME<sup>®</sup> SD USER GUIDE

---

## Visual Inspection

1. After cleaning and during and after reassembly, visually inspect all system components for visual contaminants. If any contaminants are present, re-clean following the appropriate cleaning instructions. Perform a component count in order to ensure that all components are present, and none have been lost during the cleaning process. Check for any corrosion on the laser etching of the components. If present, contact Exsurco Medical Customer Service for a Service Repair Order at 1-800-243-6049, ext. 4, or email support@exsurco.com.

## Sterilization Preparation: Loading the Amalgatome SD Sterilization Tray

1. The Amalgatome SD Sterilization Tray is designed to hold one complete set of Amalgatome SD System components.
2. Prior to loading the Amalgatome SD System into the sterilization tray, disassemble and manually clean all of the components as directed in this User Guide.
3. The facility is responsible for ensuring all their personnel are familiar with the cleaning and sterilization procedures for the sterilization tray. Failure to follow the procedures outlined in this section might affect sterility.
4. If the recommended cleaning and sterilization methods described in this section are not followed, it is your responsibility to validate your own process. Exsurco Medical is not liable for outcomes resulting in personnel not following the procedures in this user guide.
5. As with any decontamination procedure, follow the accepted guidelines for hand washing, use of personal protective equipment (PPE), etc., as recommended by the Association for the Advancement of Medical Instrumentation (AAMI) Standards and Recommended practice, Safe Handling and Biological Decontamination of Medical Devices in Health Care Facilities and in Non-Clinical Settings, Current version of ANSI/AAMI ST35.

# AMALGATOME® SD USER GUIDE

- Secure the manually-cleaned Amalgatome SD System components into their proper locations in the previously cleaned sterilization tray. There are visual guides, including part number and description, marking the correct location for the placement of each component.

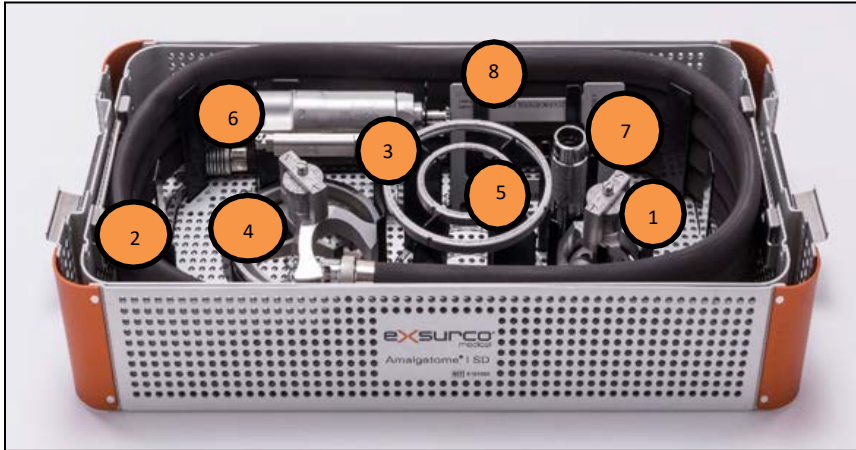

- 2-inch Cutting Head (Blade Head)
- Pneumatic Hose
- 4-inch Lock Ring
- 4-inch Cutting Head (Blade head)
- 2-inch Lock Ring
- Hand Piece
- Lock Nut Wrench
- Lock Ring Removal Tool

Figure 1a

- Do not randomly stack the components onto the internal instrument tray; each component has a designated location.
  - Ensure that the pneumatic hose is coiled carefully around the outside, taking care as to not crimp it into the compartment.
- Place the lid on top of the base, and then secure the side latches.
  - Double wrap the sterilization tray with all components inside using FDA-cleared Center for Scientific Review (CSR)-type wrap per methods listed in *ANSI/AAMI ST79, A1, A2, A3, A4*, and adhere with chemical indicator autoclave tape.

*The Amalgatome SD System is ready for sterilization.*

## CAUTIONS:

- Do not allow blood, tissue, or disinfectants to dry on any part of the Amalgatome SD System.
- Do not use cleaning agents with chlorine or chloride (e.g., saline or bleach) as the active ingredient as they are corrosive to stainless steel and can result in physical damage to the system, including rust and corrosion.
- Do not use saline as it has a corrosive effect on stainless steel and can result in physical damage to the system.
- Always use cleaning agents that are safe for surgical instruments and stainless steel.
- Never place the pneumatic hose in any kind of automated washing system.
- Always inspect instruments and devices for rust and corrosion per AORN and hospital protocols.

# AMALGATOME<sup>®</sup> SD USER GUIDE

## Sterilization

The Amalgatome SD System has only been validated for steam sterilization using the Amalgatome SD sterilization tray and FDA-cleared wrap. Should any other method or sterilization tray be used, it is the sole responsibility of the facility to validate any sterilization parameters that are not provided directly by the manufacturer. The Amalgatome SD System and sterilization tray are provided non-sterile and must be sterilized prior to use.

The wrapped sterilization tray shall be placed inside an autoclave validated in compliance with current version of *AAMI ST8, Hospital Steam Sterilizers*.

Utilize one of the two validated steam sterilization methods listed below to provide a sterility assurance level of  $10^{-6}$ . Upon completing sterilization, store the Amalgatome SD System in the sterilization packaging in a dry and dust-free place. The shelf life is dependent on the sterile barrier employed, manner in which product is stored, environment and handling conditions. A maximum shelf life for sterilized medical devices before use should be defined by each healthcare facility.

NOTE: See References & Internal Validation details in Appendix E.

Cycle Type	Pre-vacuum
Pulses	4
Set-Point Temperature	135°C/ 275°F
Exposure Time <sup>1</sup>	3 minutes
Drying Time <sup>2</sup>	16 minutes in chamber

Cycle Type	Gravity
Set-Point Temperature	135°C/ 275°F
Exposure Time <sup>1</sup>	10 minutes
Drying Time <sup>2</sup>	30 minutes in chamber

<sup>1</sup>Exposure time: Period for which the load and entire chamber is maintained at the sterilization temperature.

<sup>2</sup>Drying time: Period during which steam is removed from the chamber pressure is reduced to permit the evaporation of condensate from the load either by prolonged evacuation or by the injection and extraction of hot air or other gases. The drying time varies due to load configuration, wrapping method and material. It is the hospital's responsibility to validate the appropriate drying time with the sterilization equipment used.

# AMALGATOME<sup>®</sup> SD USER GUIDE

---

This page intentionally left blank.

# AMALGATOME<sup>®</sup> SD USER GUIDE

## Troubleshooting

*This section describes general troubleshooting information, including solutions to potential problems.*

Use the following assessment steps to confirm proper operation of the Amalgatome SD System and Sterilization Tray. If you discover a problem with any of these items, do not use the system or sterilization tray; return it to Exsurco Medical for service. For additional information, refer to the Warranty, Service, and Returns section.

- Visually inspect the system for any signs of physical damage or wear:
  - Loose parts
  - Missing or loose screws
  - Signs of being dropped or bent
  - Areas with corrosion or pitting
- Check for the proper turning of the depth adjustment knob and depth gauge.
- Verify proper connection and fit of the pneumatic hose, ensuring that both ends of the pneumatic hose (to the handpiece and the air or gas supply) fit properly to their mating receptacles. Verify the O-Ring is present
- Verify that the air supply is turned on and set to 100 psi and that the wall indicator or pressure gauge is reading correctly while the system is running.
- If no issues are observed during this assessment but performance issues are experienced, refer to the troubleshooting table below.
- Check the Amalgatome SD Sterilization Tray for any evidence of having been dropped or damaged as this can affect the closure, insert brackets, and placement of the components on the internal instrument tray. If at any time damage is observed, the sterilization tray should be returned to Exsurco Medical for service and repair.

Problem	Possible Solution
<b>System fails to spin excision ring blade when activated handpiece when engaged with the disposable excision ring blade and lock ring installed</b>	<ul style="list-style-type: none"><li>• Verify that the excision ring blade and its mating surfaces are free of lint and other particulate which can hinder free movement of the excision ring blade.</li><li>• Check the condition of the excision ring blade lock ring for any distortion or rough edges that might prevent the excision ring blade from moving properly. In this case, return the system to Exsurco Medical for service and repair.</li><li>• Verify that the on/off button is working properly by sliding the <b>ON/OFF</b> lever to the <b>ON</b> position, and then pressing down on the lever to engage the motor. If the lever does not press down on the on/off button, the system will not operate.</li><li>• Check the system for any evidence of being dropped or damaged as this can affect the operation and calibration of the depth gauge. In this case, return the system to Exsurco Medical for service and repair.</li><li>• Check pneumatic air hose for any potential leaks or cuts in it that would prevent the proper pressure required to power device.</li><li>• Check to verify that the lock nut and locking knob are assembled properly.</li></ul>

# AMALGATOME<sup>®</sup> SD USER GUIDE

	<ul style="list-style-type: none"> <li>Remove the excision ring blade, cutting head, and hose from the drive unit. Turn the pinion (gear) and check for free rotation. Rotation should feel smooth and consistent. Otherwise it can indicate particulate in the motor or damaged bearings. If this is observed, return the unit to Exsurco Medical for servicing or repair.</li> </ul>
<p><b>Actual graft thickness varies from the thickness guide on the depth setting</b></p>	<ul style="list-style-type: none"> <li>Note that the actual thickness of the graft is dependent upon operator technique, the pressure applied to the handpiece and onto the skin, and the location and condition of the tissue being harvested. For more information, refer to the Operating Instructions section.</li> <li>Note that the depth gauge – the mechanism that controls the graft thickness – is set and calibrated at the factory prior to shipment. Removal of the screws controlling the depth gauge can affect how the depth gauge performs. If the screws have been removed, return the system to Exsurco Medical for service and repair.</li> <li>Check the system for any evidence of having been dropped or damaged as this can affect the operation and calibration of the depth gauge. In this case, return the system to Exsurco Medical for service and repair.</li> </ul>
<p><b>Variation in graft thickness is observed during the procedure</b></p>	<ul style="list-style-type: none"> <li>Note that the actual thickness of the graft is dependent upon operator technique, the pressure applied to the handpiece and onto the skin, and the location and condition of the tissue being harvested. For more information, refer to the Operating Instructions section.</li> <li>Check all connections and ensure that the system is assembled correctly, and the disposable excision ring blade is engaged with the pinion to allow free and uniform movement of the excision ring blade.</li> <li>Check the air connection to ensure the pressure setting is 100 psi with the system running, allowing the motor to provide continuous operation to the excision ring blade without interruptions in power. An interruption can cause random bursts of power that might affect the graft thickness.</li> <li>Verify that the graft site is lubricated with sterile water or sterile mineral oil in order to decrease any excision ring blade resistance.</li> <li>Check the system for any evidence of having been dropped or damaged as this can affect the operation and calibration of the depth gauge. In this case, return the system to Exsurco Medical for service and repair.</li> </ul>
<p><b>Graft quality</b></p>	<ul style="list-style-type: none"> <li>Verify that the graft site is lubricated with sterile water or sterile mineral oil to decrease any excision ring blade resistance.</li> <li>Check to make sure there is no debris or defects on the excision ring blade.</li> <li>Note that the actual thickness of the graft is dependent upon operator technique, the pressure applied to the handpiece and onto the skin, and the location and condition of the tissue being harvested. For more information, refer to the Operating Instructions section.</li> <li>Note that the depth gauge—the mechanism that controls the graft thickness—is set and calibrated at the factory prior to shipment. Removal of the screws controlling the depth gauge can affect how the depth gauge performs. If the screws have been removed, return the system to Exsurco Medical for service and repair.</li> <li>Check the system for any evidence of having been dropped or damaged as this can affect the operation and calibration of the depth gauge. In this case, return the system to Exsurco Medical for service and repair.</li> </ul>

# AMALGATOME<sup>®</sup> SD USER GUIDE

<p><b>Disposable excision ring blade does not seem to be working properly</b></p>	<ul style="list-style-type: none"> <li>• Verify that the excision ring blade and its mating surfaces are free of lint and other foreign objects which can hinder free movement of the excision ring blade.</li> <li>• Verify that the excision ring blade is not clogged with debris, skin, or fabric from the Operating Room (OR) towels, sponges, or drape material, which can hinder free movement of the excision ring blade.</li> <li>• Check for any visible nicks or dings in the excision ring blade caused by running over metal objects. Do not attempt to cut exposed bone, tendon, or similar material. The system is intended to cut skin only.</li> </ul>
<p><b>Uneven or chattered edges on the skin graft</b></p>	<ul style="list-style-type: none"> <li>• Operate the system with a slow and steady speed. Moving too fast does not allow the user to adjust to body contours or irregularities in tissue.</li> <li>• Reduce speed and review proper angle and pressure to ensure that the correct technique is being used.</li> </ul>
<p><b>Crescent shaped appearance in the skin graft</b></p>	<ul style="list-style-type: none"> <li>• Operate the system with a slow and steady speed. Moving too fast does not allow the user to adjust to body contours or irregularities in tissue. This results in crescent moon shaped patterns or uneven thickness of grafts.</li> <li>• Reduce speed and review proper angle and pressure to ensure that the correct technique is being used.</li> </ul>
<p><b>Inadvertently/unintentionally dissected skin graft during harvesting</b></p>	<ul style="list-style-type: none"> <li>• The excision ring blade cuts with the trailing edge. Attempting to keep the instrument too flat can inadvertently lift the cutting edge away from the recovery site.</li> <li>• Reduce speed and review proper angle and pressure to ensure that the correct technique is being used.</li> </ul>
<p><b>Gradual loss of rpm or power</b></p>	<ul style="list-style-type: none"> <li>• Re-lubricate the drive unit by placing 1-3 drops of sterile mineral oil in the air inlet and run the device away from surgical field to ensure even internal distribution.</li> </ul>  <p><b>NOTE:</b> it is not recommended that this be performed after every use due to the risk of mineral oil buildup in the hose. This can be performed in the operating room just perform away from operating zone.</p>
<p><b>Instant loss of function of the drive unit (device no longer capable of performing an operation)</b></p>	<ul style="list-style-type: none"> <li>• Return the device to Exsurco Medical for service and repair.</li> </ul>

# AMALGATOME<sup>®</sup> SD USER GUIDE

**Lever depression feels “tacky” or the lever does not freely rebound after release of pressure**

- Re-lubricate the activation plunger using 1 drop of sterile mineral oil and exercise the lever in the ON position until it is no longer “tacky”.



**O-Ring on Handpiece appears worn**

- Normal wear of the O-ring is expected. The O-ring will be replaced during the annual Preventive Maintenance.

**Pneumatic Hose difficult to connect to handpiece**

- Lubricate the O-ring prior to connecting the air hose with sterile mineral oil. This will help make the female end of the air hose easier to attach to the male end of the handpiece using the toggle bars. Do not bend hose at a 90° angle at the connection site. Do not use excessive force during the process.

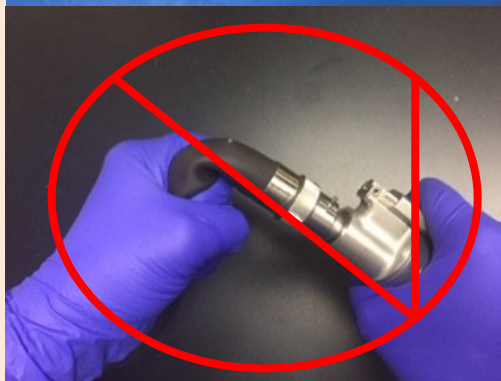



# AMALGATOME<sup>®</sup> SD USER GUIDE

---

## Warranty, Service, and Returns

*This section describes the limited warranty, service requirements, and returns policy.*

### **Limited Warranty**

Exsurco Medical (“Exsurco”) warrants that each new Amalgatome SD System, Sterilization Tray, and its components have been tested and inspected and have left the factory in proper working condition. Exsurco warrants the product is free from manufacturing defects in material and workmanship under normal use and service for a period of one year from date of delivery by Exsurco to the customer. The pneumatic hose must be replaced every six (6) months or sooner if there is evidence of wear (holes/ cuts/ tears). The hose is a consumable product and NOT covered as part of the one (1) year warranty. The sterile, disposable excision ring blade is not warranted beyond the expiration date stated on the product labeling.

- The Amalgatome SD System and Sterilization Tray is guaranteed to be free from defects in material and workmanship when maintained by the customer, properly cleaned, and used under normal circumstances for its intended purpose.
- Any Amalgatome SD System and Sterilization Tray that is placed by Exsurco under an installment purchase agreement and requires repair service during the term of such placement agreement shall be repaired in accordance with the terms of such agreement.

During the warranty period, Exsurco shall repair, or at its sole opinion, replace the defective product or part without cost incurred to the customer. Defective parts replaced under this warranty shall become the property of Exsurco. This warranty does not cover damage caused by misuse, abuse (dropped or damaged), accident, neglect, or any use not prescribed in this user guide. If the system becomes defective because of misuse or abnormal conditions of operations, these repairs shall be charged to the customer. All products returned for warranty or non-warranty repair must be through the Exsurco return procedure. For more information, refer to the Returns information below. In no event shall Exsurco be liable for any incidental, indirect, consequential, or punitive damages in connection with the acquisition or use of Exsurco product. Further, this warranty shall not apply to, and Exsurco shall not be responsible for, any loss or damage arising in connection with the purchase or use of Exsurco product that has been repaired by anyone other than Exsurco, or altered in any way so as to, in the judgment of Exsurco Medical, affect the usability or reliability of the product. If this happens, the product repairs shall be charged to the customer. This limited warranty is exclusive and in lieu of all other warranties, express or implied, and of all other obligations or liabilities on Exsurco’s part, and Exsurco neither assumes nor authorizes any representative or other person to assume for it any other liability in connection with this product.

Exsurco disclaims all other warranties, express or implied, including any implied warranty of merchantability or of fitness for a particular purpose or application or warranty of quality as well as any express or implied warranty to patients.

The Exsurco Medical Amalgatome SD System is intended for use only with the Amalgatome SD disposable excision ring blade. Using another manufacturer’s excision ring blades in conjunction with the Amalgatome SD voids the product warranty.

# AMALGATOME<sup>®</sup> SD USER GUIDE

---

## Service

The Amalgatome SD System and Sterilization Tray contains no serviceable parts. The system must be returned to Exsurco Medical for servicing. Exsurco Medical performs all repairs in-house by our trained Technical Service team.

**NOTE:** Exsurco Medical cannot be held liable for any system malfunctions resulting from repairs or service performed by anyone other than Exsurco Medical.

Do not attempt to open or disassemble the handpiece. It is a factory-sealed unit with no user serviceable parts inside. If this happens, it voids the warranty and the customer must return the handpiece to Exsurco Medical for repair that shall be charged to the customer.

Do not attempt to service the sterilization tray, including but not limited to performing maintenance on any of components. The warranty will be voided if the customer performs any maintenance on the sterilization tray.

Do not attempt to remove the screws and disassemble the depth gauge on the cutting head for any reason. It has been factory calibrated to provide optimum cutting performance. If this happens, it voids the warranty and the customer must return the system to Exsurco Medical for repair that shall be charged to the customer. All products returned for warranty or non-warranty repair must be through the Exsurco Medical return procedure. For more information, refer to the Returns information below. Exsurco Medical performs all service of the Amalgatome SD system.

Our Technical Service Department can be contacted at 1-800-243-6049, ext. 5, or email [support@exsurco.com](mailto:support@exsurco.com) to answer any general questions that relate to the operation, warranty, and service of the system.

The Amalgatome SD System must be returned annually for inspection and preventative maintenance. The pneumatic hose must be replaced every six (6) months or sooner if there is evidence of wear (holes/ cuts/ tears). Customer is responsible for replacing hose. Annual factory maintenance is strongly recommended in order to ensure consistent operation and accuracy.

## Returns

When it is necessary to return the Amalgatome SD System or Sterilization Tray for inspection and preventative maintenance, warranty service, or non-warranty service, please contact Customer Service at 1-800-243-6049, ext. 4, or email [support@exsurco.com](mailto:support@exsurco.com) to receive a Return Material Authorization (RMA) or Service Repair Order (SRO).

Product will not be accepted without an RMA/SRO. Exsurco Medical shall provide the customer with the approved return shipping container. The customer is responsible for the return freight.

When the customer is returning the system, we require proof of sterilization documents upon receipt of the RMA or SRO. If proof of sterilization is not included with the system, the system shall be returned for sterilization. Exsurco Medical does not accept product that has been used without being sterilized first or has not been shipped with the sterilization documents. If it is a new product or has not been used, then Customer Service shall note that on the RMA/SRO documentation.

# AMALGATOME<sup>®</sup> SD USER GUIDE

---

While the system is at Exsurco Medical for repair, a loaner if available can be requested and shipped to the customer. Please confirm this with Customer Service at time of the return request.

Upon receiving returned product at Exsurco Medical, the product is reviewed by our Technical Service Department. Customer Service shall provide the customer with a service estimate for any repairs not covered under warranty or extended warranty. Exsurco Medical performs all product service on-site in our Technical Service Department.

When product is ready for shipment back to the customer, Exsurco Medical covers the freight and returns the product in an approved protective shipping container.

Exsurco Medical stands behind the quality of our products. Should you have a complaint or not be completely satisfied with your product, please call our Customer Service team to register a complaint. Our Customer Service team is available Monday through Friday, 8 am to 5 pm ET and is here to assist you in any way. Email [support@exsurco.com](mailto:support@exsurco.com) or call 1-800-243-6049, ext. 4. To help investigate the event further, we require the following information:

- Name, address, and account number
- Phone number and email address
- Part/product that the complaint is being filed on
- Serial number (equipment) or lot number (disposable)
- A description of the event:
  - Be as descriptive as possible.
  - Provide pictures, if available.
- Loaner requirements if available upon request

Once a complaint is received, we may contact you for more information. When the product is returned, a preliminary evaluation is generally conducted, and the product is repaired (if required) and restored to conformance prior to being shipped back. A closure letter shall be provided advising you of the outcome of the investigation regarding the reported event.

# AMALGATOME<sup>®</sup> SD USER GUIDE

---

This page intentionally left blank.

# AMALGATOME® SD USER GUIDE

## Appendix A: Technical Specifications

### Amalgatome SD System Specifications

Specification	Value
<b>Maximum Graft Width</b>	2-inch Cutting Head: 2 in. (5.08 cm) 4-inch Cutting Head: 4 in. (10.16 cm)
<b>Air Consumption</b>	11 cfm
<b>Input Air Pressure</b>	100 psi, with system running (6.2 bar) Hospital Grade Air (compressed air, nitrogen)
<b>Storage and Transport (Amalgatome SD System)</b>	As per internal hospital procedure.
<b>Weight and Measurement</b>	Assembled 2-inch handpiece: 3.1 lb. Assembled 4-inch Unit: 3.7 lb. Handpiece and Pneumatic Hose weight: 2.7 lb., length: 15 feet Complete SDSYSTEM024 in sterilization tray: 17.8 lb. Weight of Empty Sterilization Tray: 9.7 lb. Dimensions of the fully assembled tray: 21 x 10.25 x 4 in.
<b>Sterile, Single-Use Excision ring blades Environmental Conditions</b>	It is recommended these materials be stored in the provided packaging in a cool (under 32° C (90°F)), clean and dry area. Humidity Condition Storage Range: 30-70%

### Amalgatome SD Sterilization Tray Specifications

Specification	Value
<b>Sterilization</b>	Steam sterilization only in validated Amalgatome SD Sterilization Tray
<b>Cycle</b>	Gravity or pre-vacuum steam sterilization
<b>Wrap</b>	FDA approved steam sterilization double wrap
<b>Storage and Transport (Amalgatome SD System)</b>	As per internal hospital procedure
<b>Weight</b>	Lid: 1.48 lb Base: 3.64 lb Internal Instrument Tray: 4.56 lb Complete Sterilization Tray: 9.7 lb Complete SDSYSTEM024 in sterilization tray: 17.8 lb
<b>Dimensions</b>	Length: 21 in., Width: 10.25 in., Height: 4 in.

# AMALGATOME<sup>®</sup> SD USER GUIDE

---

This page intentionally left blank.

# AMALGATOME® SD USER GUIDE

## Appendix B: Parts Information

### Part #: SDSYSTEM024

Description: Exsurco Amalgatome SD Skin Grafting and Wound Debridement System (2-inch and 4-inch)

Quantity	Part #	Description
1 each	X101016	Amalgatome SD Handpiece (Drive Unit)
1 each	X101005	Amalgatome SD Sterilization Tray
1 each	X101004	Amalgatome SD Pneumatic Hose (length: 15 ft)
1 each	X100968	Amalgatome SD 2-inch Cutting Head
1 each	X100969	Amalgatome SD 4-inch Cutting Head
1 each	X100768	Amalgatome SD 2-inch Lock Ring
1 each	X100825	Amalgatome SD 4-inch Lock Ring
1 each	X100966	Amalgatome Lock Ring Removal Tool
1 each	X101133	Amalgatome Lock Nut Wrench
1 each	X101456	Amalgatome SD User Guide
1 each	X101491	Amalgatome SD Intro Letter

Sterile, Disposable Excision ring blades sold separately. Use only the excision ring blades listed below for this product. Failure to do so voids the warranty and can cause injury:

- Part #: X101789- 2-inch ASD Excision ring blade (5 each/box)
- Part #: X101788- 4-inch ASD Excision ring blade (5 each/box)

# AMALGATOME<sup>®</sup> SD USER GUIDE

Exsurco also offers the following Amalgatome SD System configurations in just one size:

**Part #: SDSYSTEM02**

Description: Exsurco Amalgatome SD Skin Grafting and Wound Debridement System (2- inch)

Quantity	Part #	Description
1 each	X101016	Amalgatome SD Handpiece (Drive Unit)
1 each	X101005	Amalgatome SD Sterilization Tray
1 each	X101004	Amalgatome SD Pneumatic Hose (length: 15 ft)
1 each	X100968	Amalgatome SD 2-inch Cutting Head
1 each	X100768	Amalgatome SD 2-inch Lock Ring
1 each	X100966	Amalgatome Lock Ring Removal Tool
1 each	X101133	Amalgatome Lock Nut Wrench
1 each	X101456	Amalgatome SD User Guide
1 each	X101491	Amalgatome SD Intro Letter

**Part #: SDSYSTEM04**

Description: Exsurco Amalgatome SD Skin Grafting and Wound Debridement System (4-inch)

Quantity	Part #	Description
1 each	X101016	Amalgatome SD Handpiece (Drive Unit)
1 each	X101005	Amalgatome SD Sterilization Tray
1 each	X101004	Amalgatome SD Pneumatic Hose (length: 15 ft)
1 each	X100969	Amalgatome SD 4-inch Cutting Head
1 each	X100825	Amalgatome SD 4-inch Lock Ring
1 each	X100966	Amalgatome Lock Ring Removal Tool
1 each	X101133	Amalgatome Lock Nut Wrench
1 each	X101456	Amalgatome SD User Guide
1 each	X101491	Amalgatome SD Intro Letter



# AMALGATOME<sup>®</sup> SD USER GUIDE

---

## **Ordering Information**

To place an order for the Amalgatome SD System, please contact our Customer Service department at 1-800-243-6049, ext. 4, or email [support@exsurco.com](mailto:support@exsurco.com). For a price quote and all product-related questions, please contact your local Exsurco Medical sales representative or contact our Sales department at 1-800-243-6049, ext. 1, or email [sales@exsurco.com](mailto:sales@exsurco.com)

The Amalgatome SD Sterilization Tray is only sold as a replacement product to current customers. To order replacement components separately, please contact Customer Service at 1-800-243-6049, ext. 4, or email [support@exsurco.com](mailto:support@exsurco.com).





# AMALGATOME<sup>®</sup> SD USER GUIDE

---







This page intentionally left blank.

# AMALGATOME<sup>®</sup> SD USER GUIDE

## Appendix C: Glossary of Symbols

Symbol	Definition
	Serial Number
	Batch Code/Lot Number
	Manufacturer
	Caution: USA federal law restricts this system to sale by or on the order of a physician.
	Use by date. This symbol is intended to indicate that the system should not be used after the end of the date shown.
	Symbol for method of sterilization using radiation.
	Symbol indication that the system has not been sterilized.
	Do not reuse. Single use, use only once.

# AMALGATOME<sup>®</sup> SD USER GUIDE

Symbol	Definition
	Caution
	Consult instructions for use
	Keep product dry
	Do not use if package is damaged
	This side up
	Sharp object
	General warning sign

# AMALGATOME<sup>®</sup> SD USER GUIDE

## Appendix D: Quick Reference Guides

### Setup



# AMALGATOME<sup>®</sup> SD USER GUIDE

## Postoperative Procedure

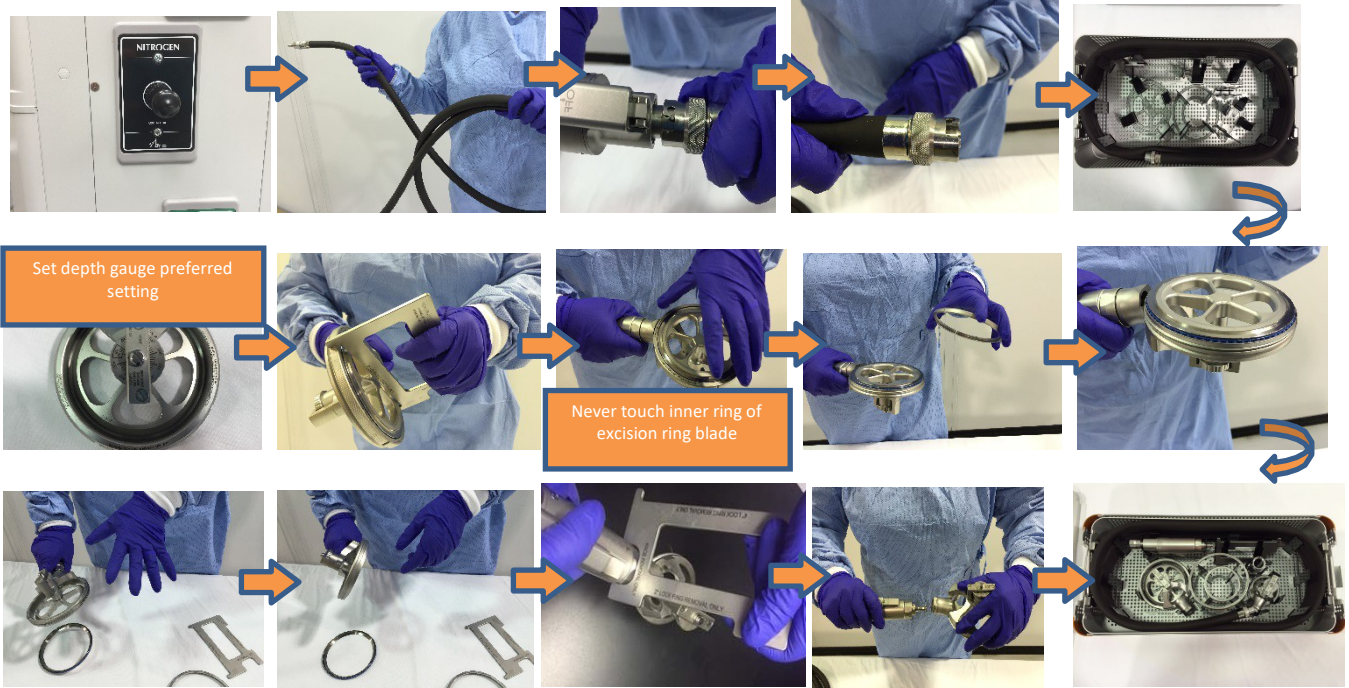

# AMALGATOME<sup>®</sup> SD USER GUIDE

## Manual Cleaning of the Reusable System

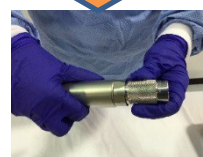
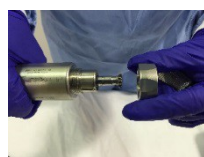
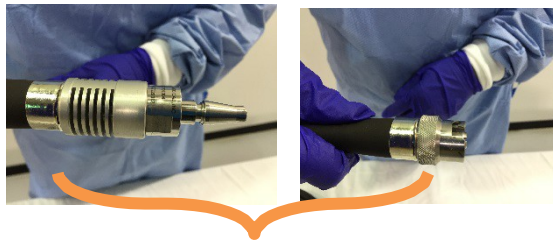
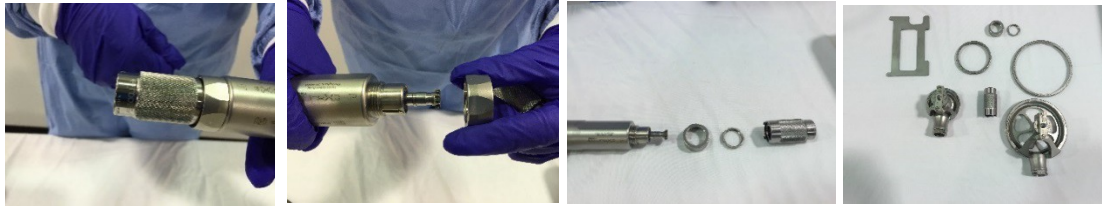

Lint-free wipe

Dry

Reassemble lock nut onto handpiece Load ASD into Sterilization Tray

# AMALGATOME<sup>®</sup> SD USER GUIDE

---

This page intentionally left blank.



# AMALGATOME® SD USER GUIDE

## Appendix E: References for Sterilization and Details of Validation Report

### References

- Current version of ANSI/AAMI/ISO 17665-1 – Sterilization of health care products – Moist heat – Part 1: Requirements for the development, validation and routine control of sterilization process for medical devices
- Current version of AAMI TIR12 – Designing, testing and labeling reusable medical devices for reprocessing in health care facilities: A guide for medical device manufacturers
- Current version of ANSI/AAMI ST81 – Sterilization of medical devices – Information to be provided by the manufacturer for the processing of resterilizable medical devices
- Current version of ISO 17664 – Sterilization of medical devices – Information to be provided by the manufacturer for the processing of resterilizable medical devices
- Based on guidelines outlined in AAMI TIR12 – Designing, testing and labeling reusable medical devices for reprocessing in health care facilities: A guide for medical device manufacturers
- Current version of AAMI TIR30 – A compendium of processes, materials, test methods, and acceptance criteria for cleaning reusable medical devices
- U.S. Department of Health and Human Services, Food and Drug Administration, Center for Devices and Radiological Health, and Office of Device Evaluations (March 17, 2015). Reprocessing Medical Devices in Health Care Settings: Validation Methods and Labeling - Document Guidance for Industry and Food and Drug Administration Staff
- Current version of ANSI/AAMI ST8 – Hospital steam sterilizers
- Current version of ANSI/AAMI ST79/A1/A2/ A3/A4 – Comprehensive guide to steam sterilization and sterility assurance in health care facilities (Consolidated text)

### Internal Validation Reports

- Steam Sterilization Efficacy Validation of the Amalgatome® SD Reusable Surgical Device Report - Project 154421.
- Cleaning Efficacy Validation of the Amalgatome® SD Reusable Surgical Device and Sterilization Tray – Manual Cleaning Report- Project 154421 Part III.
- Cleaning Efficacy Validation of the Amalgatome® SD Reusable Surgical Device and Sterilization Tray – Automated Cleaning Validation Summary Report- 165647
- The cleaning agents listed below were used by Exsurco Medical when validating the instructions for processing provided in this document.

Supplier	Designation	Comment
Steris	Prolystica® 2X Concentrate Enzymatic Presoak	neutral pH or instrument safe enzymatic cleaner

- Exsurco Medical does not recommend these products in preference to others that are available. Other products may perform equally in conjunction with the equipment being used. The instructions provided by the supplier of the detergents should be followed. Personal protection for operators should be provided in accordance with the supplier’s instructions and safety data sheets. Suitability of alternative agents should be checked by reference to the supplier’s information and/or physical testing.

# AMALGATOME<sup>®</sup> SD USER GUIDE

---

This page intentionally left blank.

# AMALGATOME<sup>®</sup> SD USER GUIDE

---

## Help Information

### Contact Information

Please refer to the information below for contacting Exsurco Medical directly for any of your questions, comments, or concerns about the Amalgatome SD.

**Phone: 1-800-243-6049**

**Website: [www.exsurco.com](http://www.exsurco.com)**

Press the number below for the following departments or email at:

1 – Sales & Clinical Support:  
[sales@exsurco.com](mailto:sales@exsurco.com)

2 – Marketing & Product Inquiries:  
[information@exsurco.com](mailto:information@exsurco.com)

4 – Customer Service or to Report a Quality Concern: [support@exsurco.com](mailto:support@exsurco.com).

5 – System or Technical Service:  
[support@exsurco.com](mailto:support@exsurco.com)

6 – Quality Department: [support@exsurco.com](mailto:support@exsurco.com)

7 – Accounting Department:  
[support@exsurco.com](mailto:support@exsurco.com)

This page intentionally left blank.

This page intentionally left blank.



Exsurco Medical  
10804 Green Road  
Wakeman, OH 44889

Exsurco Medical  
P.O. Box 376  
Vermillion, OH 44089

© 2019 Exsurco Medical, Inc. All Rights Reserved  
Amalgatome® and Exsurco® are registered trademarks of Exsurco Medical, Inc.  
PN: X101456, Rev. E

Date Issued: October 16, 2019